



GÉANT Network Evolution

GÉANT Symposium

Mian Usman, GÉANT, Oct 2017

www.geant.org



Agenda

- GÉANT Network Overview
- The Network Evolution process – so far
- Network Traffic Forecast
- Vendor Engagement - Industry Trends
- Network Evolution Objectives
- Network Transport Layer
- Network Packet Layer
- Network Management and Operating System
- Progress and Summary



GÉANT Network – IP/MPLS Backbone

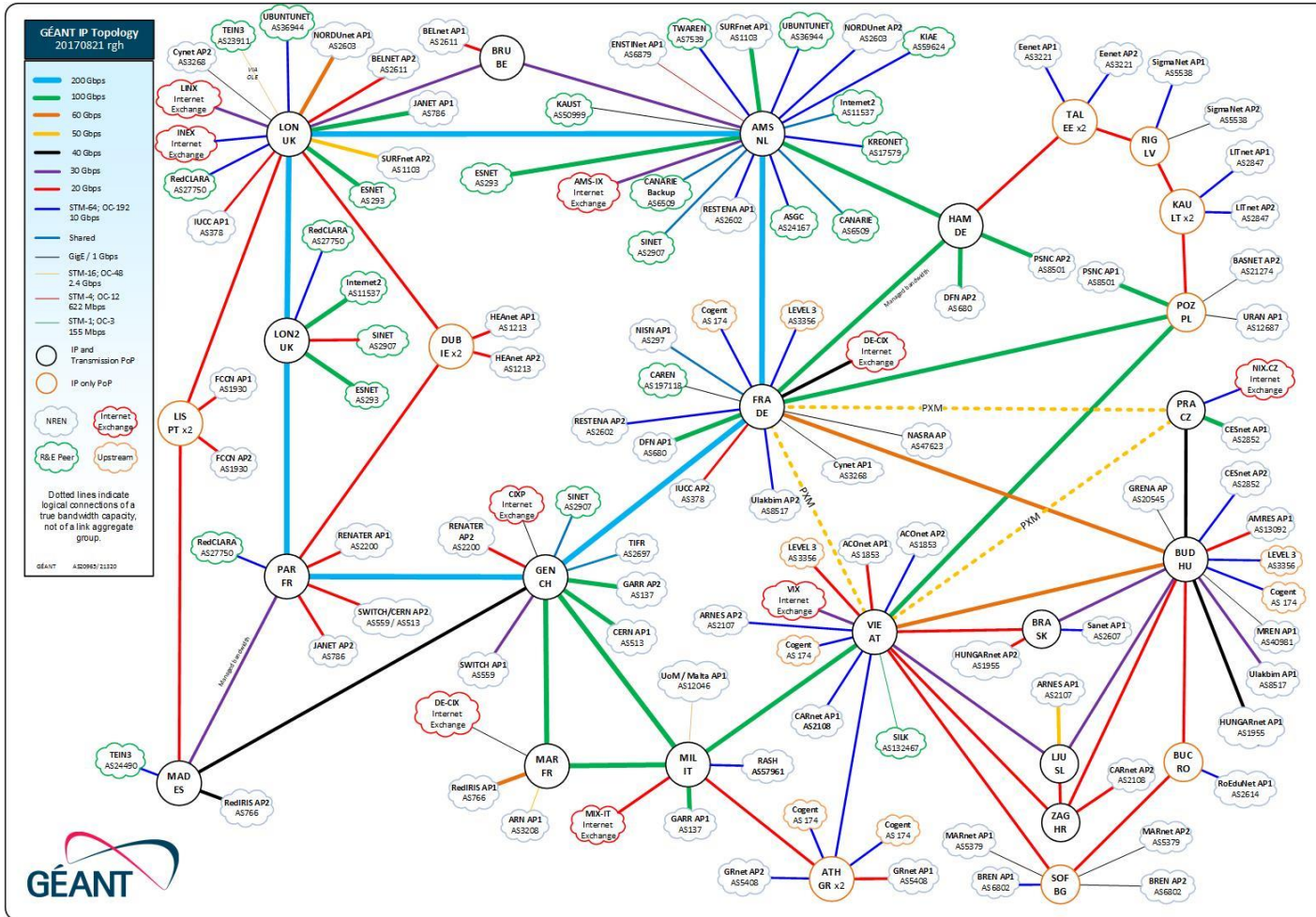

- Global R&E IP – connects the NRENs and other regional R&E networks
- LHCONe – connects NRENs and other regional networks for LHC related data exchange
- IAS – connects NREN to ISP and CDN networks
- Over 500 Gbps peak traffic
- Less than 10% of the traffic falls outside of these 3 overlays



GÉANT Network – International Connectivity

Data transfer tests in Q1 2017 between 10G servers in GÉANT and AARNET achieved 9.73Gbps over 48h over R&E networks, whereas over commercial links this was only 1.77Gbps.



- The GÉANT network connects at high speed directly to most of the world regions.
- Worldwide connectivity achieved through partners R&E networks where direct links are not present.



GÉANT Network – Platforms

- Transmission layer based on Infinera DTNx Platform
- IP/MPLS layer based on Juniper MX series Platform
- Single vendor solution
- High backplane capacity
- High space and power requirements
- No data-plane programmability



Juniper - MX960



XTC-10



XTC-4



Network Evolution Process – so far

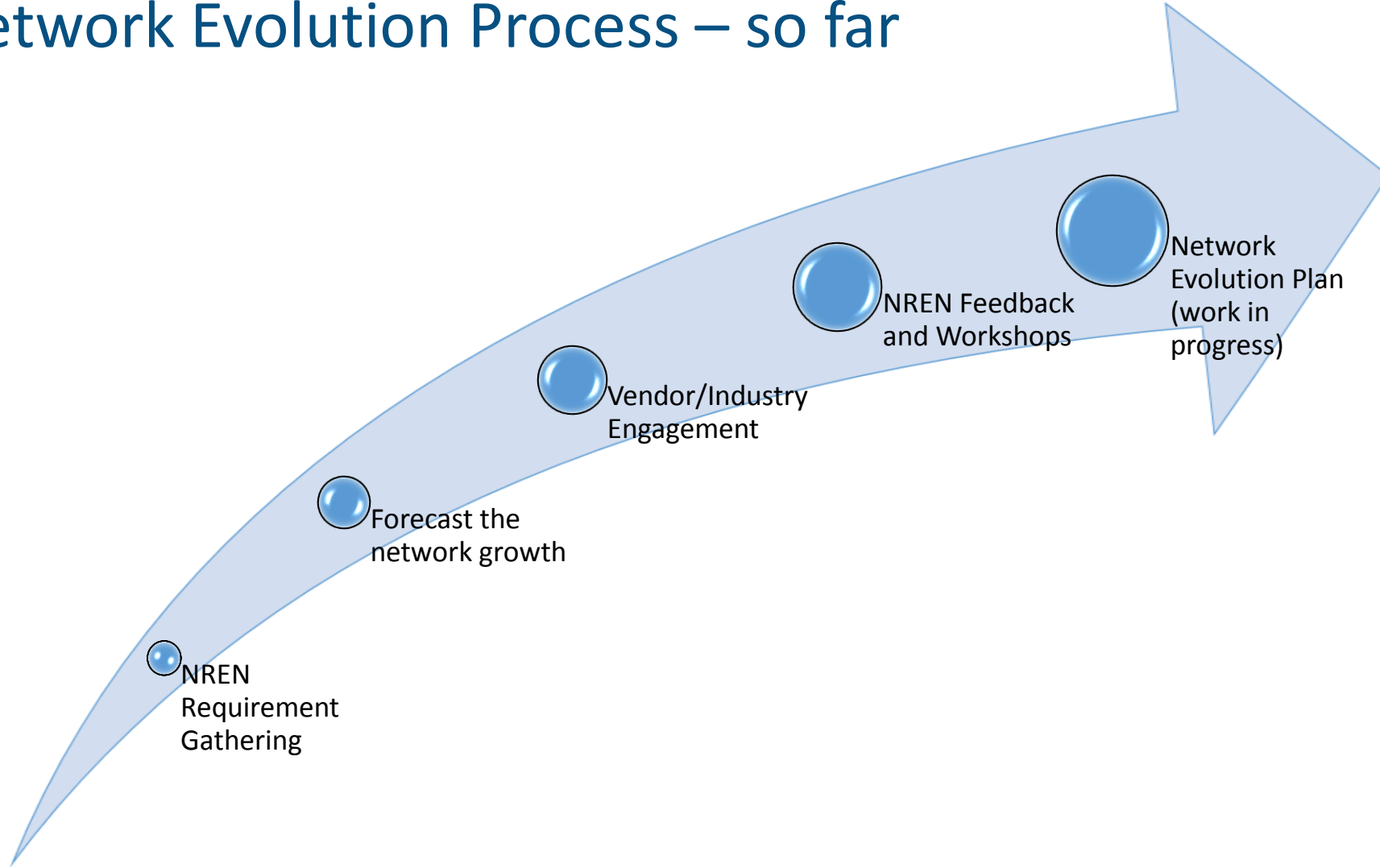



Traffic Forecast

Over 60% year on year growth on IP MPLS means 140 times in 10 years

GÉANT TRAFFIC PB PER QUARTER

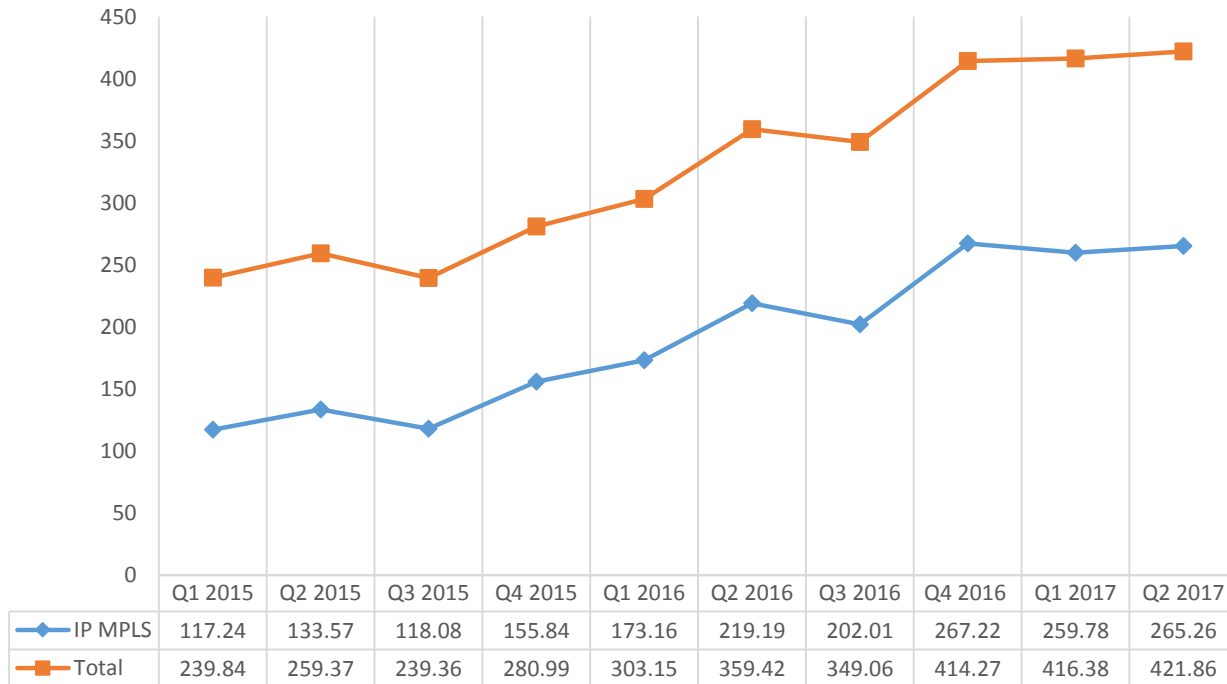

In Q2 2017 GÉANT received about 4.6 Petabytes of traffic per day, that is 4.6 millions of Gigabytes.

Between 2015 and 2016 the IP/MPLS traffic on the GÉANT network grew by 64%. This has reduced to ~50% in the last 4 quarters.

LHC and the high energy physics community has been one of the major drivers for growth.



Vendors Engagement

Meetings and workshops held with over a dozen network hardware and software vendors



THE ELASTIC NETWORK



TELECOM INFRA PROJECT



www.geant.org





Industry Trends

Web Scale companies redefining the industry

- Moving towards disaggregation
 - From a monolithic block to a modular, flexible and best in class
 - Clean separation between hardware and software – each innovate independently of other
- Transport Layer
 - Open Line System
 - Data Centre Interconnects (DCI) or External Transponders
- Packet Layer
 - Merchant Silicon
 - White/Brite Boxes
 - Third Party NOS



Industry Trends

Open Line System and Disaggregation at Transport Layer

- Support for multiple technologies/vendors over a single line system
- Offer alien wave transport as a managed service
- Integrated 3rd party DWDM pluggable available in various terminal technologies and vendors
- Still benefit from a single vendor providing end-to-end optical management
 - channel & span equalization, DCN connectivity (OSC), ALS, Alarm reporting.

- No Disaggregation: Entire transport network acts as one element

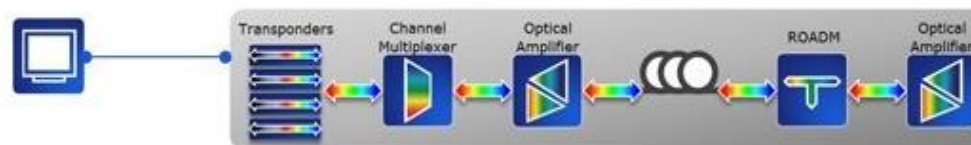

- Fully Disaggregated: Everything is a separate network element

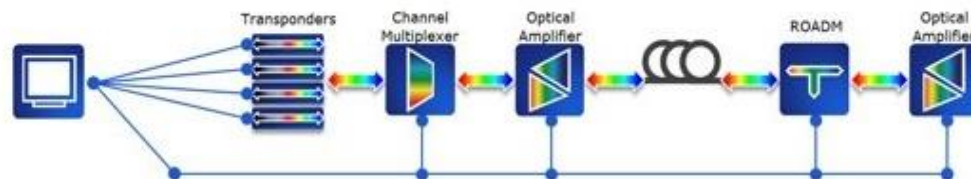

- Partially: Transponding is one element, OOLS is second.

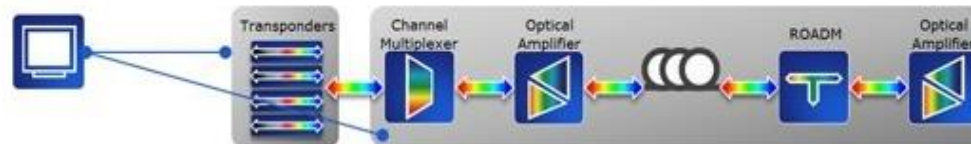



Disaggregation – Packet Layer

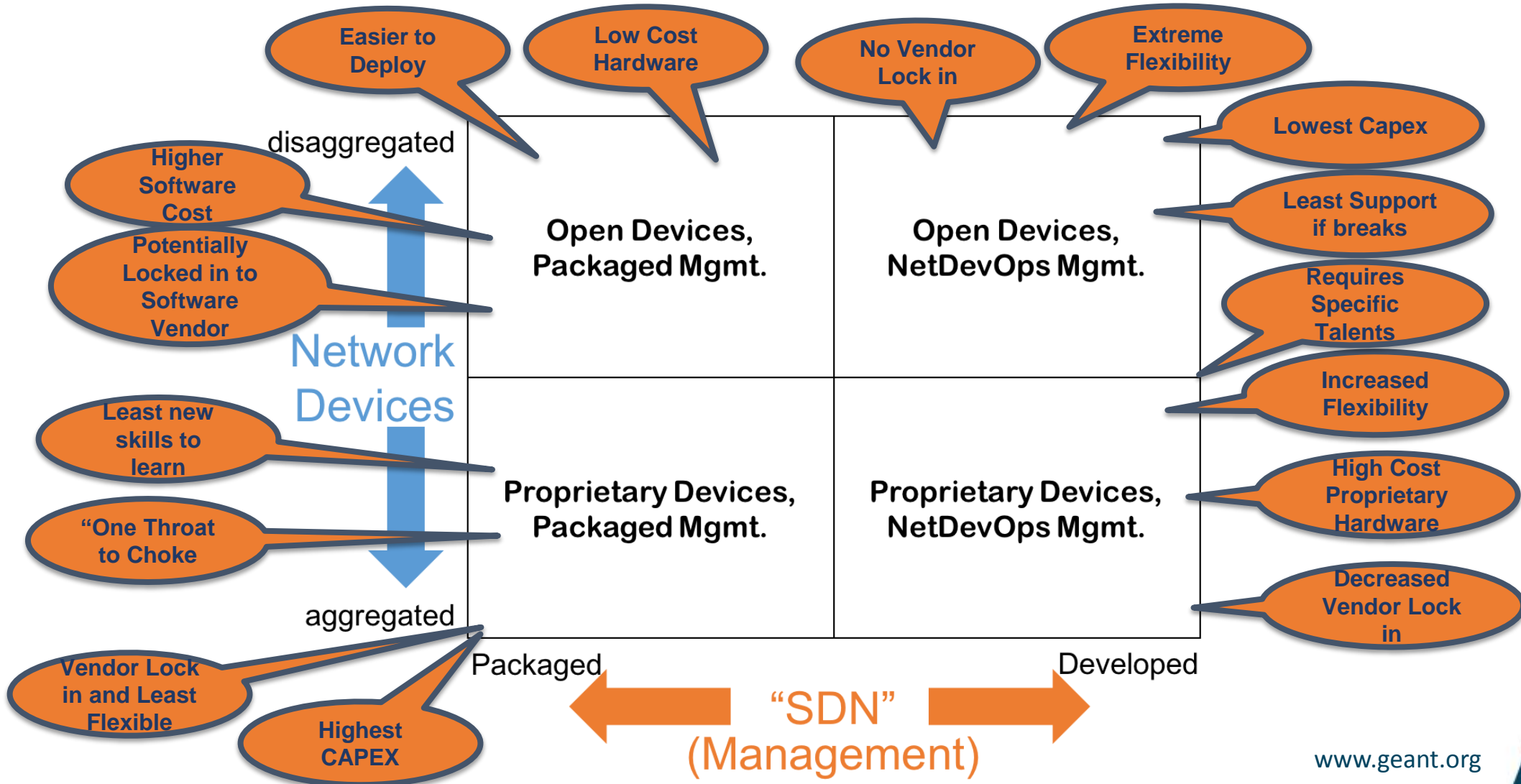



Network Evolution - Objectives

What are we trying to achieve?

- Support exponential growth in network traffic
 - Over 60% year on year growth - traffic expected to double every 18 months
 - Find cost effective ways to support the traffic growth
- Scale faster
- Increase space and power efficiencies
- Remove dependence on a single vendor solution
 - Move away from monolithic to modular architecture
 - Separate the hardware and software innovation
- Improve agility and ease of deployment
- Improve network visibility and reduce operational costs



Transport Layer

Partly disaggregated line system architecture allows for use of third party transponders on line system by defining a DEMARC at the MUX. This allows for best in breed selection of transponder and avoid vendor locking both financially and in terms of innovation curve.

This also enable better infrastructure sharing by lowering the cost of sharing capacity over fibre.

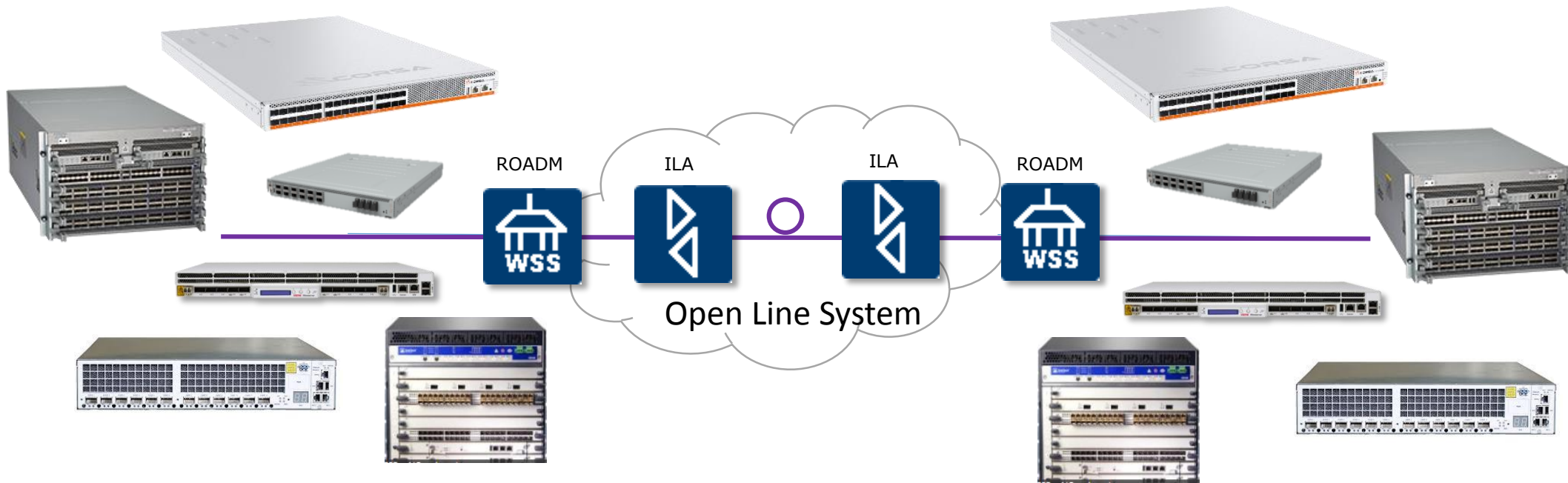



Network Evolution – Transport Layer - Transition

The Data centre interconnects (DCIs) or external transponder boxes are over 6 times cheaper than DTNx

DCI integrated solution

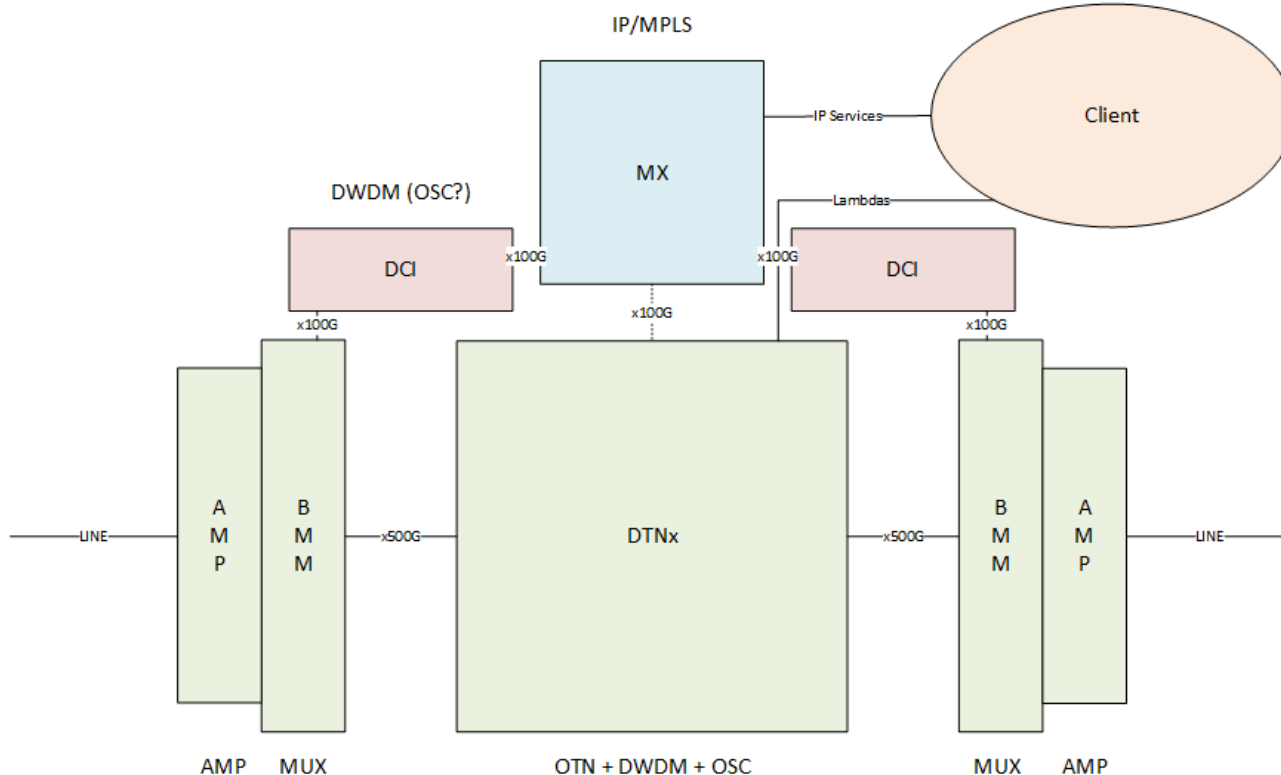

- Use DCI to provision bandwidth for high capacity IP/MPLS trunks
- Keep DTNx for link management and lambda provisioning greatly simplifying DCI role and minimising risk
- Integration of DCI allows for growth offset and generate enough spares to allow to cease spending on DTNx platform
- DCI are AC powered 1RU
- DCIs can be re-used after line system re-procurement in 2020/2021



Packet Layer

- Over 64% YoY growth on IP MPLS means 140 times in 10 years
- Forecasted traffic means current Juniper MX platform may not be scalable enough to support the growth
- Gather expected traffic growth and requirements of larger Overlays e.g. LHCONe to understand if possible to disaggregate and deliver services on a different platform
- Openness and programmability of merchant silicon allows for disaggregation of SW and HW
- Evaluations of disaggregated HW and SW components could result in large cost savings on longer terms for GÉANT and R&E community
- Testing of available solutions and evaluation or potential solutions currently in progress

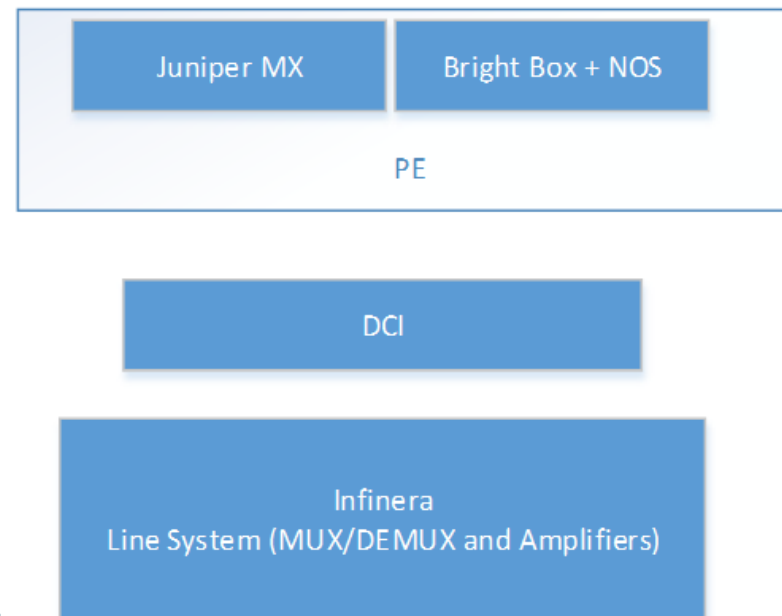



Network Operating System

- Router operating systems contain at least **30 million lines of code** - all completely obscured in a binary.
- 80% of it is completely unnecessary in the average environment
- Disaggregated software means the control plane can be made modular
 - We can choose to only develop / deploy what is necessary for the required function
 - Simply core/underlay
 - Feature rich edge/overlay
- Service development much more agile
- Bug fixes and regression testing simpler

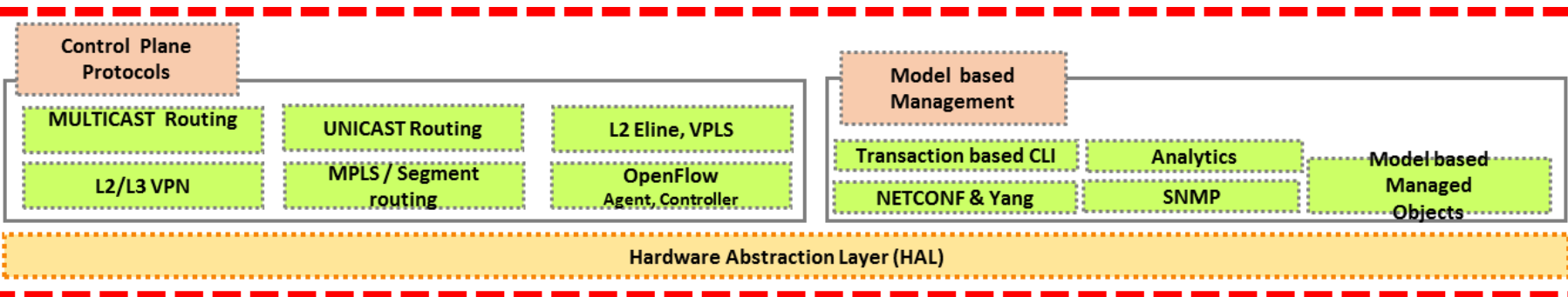
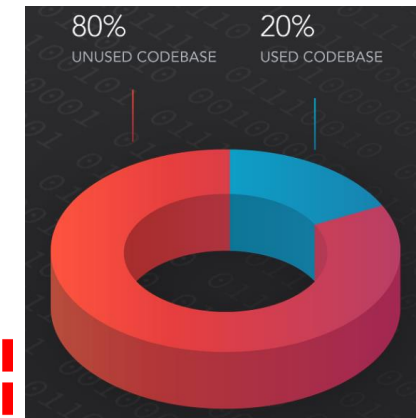

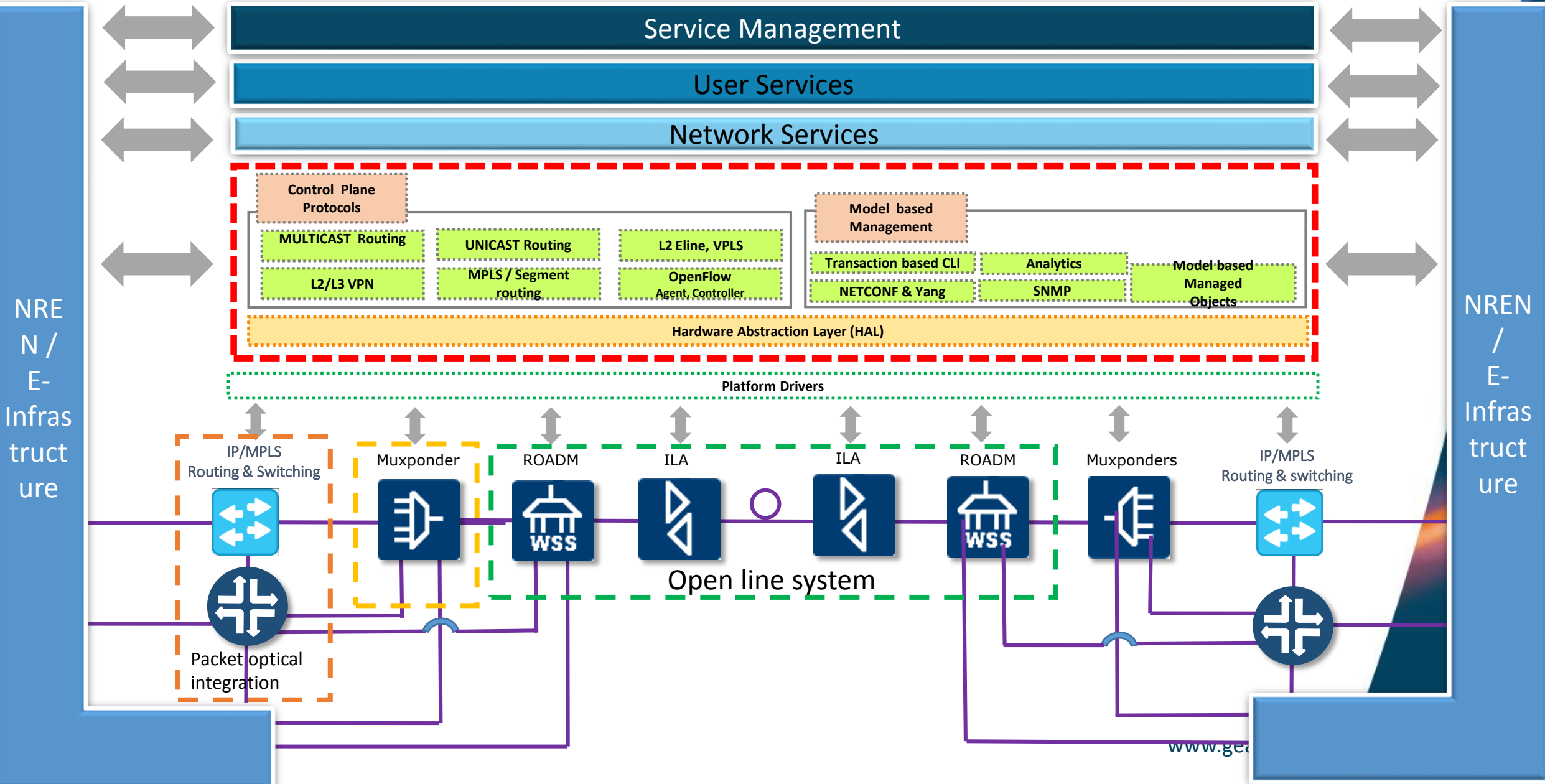



GÉANT Connectivity Regional Studies

Regional Studies will help formulate the long term strategy of the GÉANT connectivity in different regions – Four regional studies on-going

- GÉANT traffic requirements show need for Dark Fibre in core network locations
- Current western ring matches well required fibre footprint
- Eastern ring requires some modifications, but good portion of links are in the right place
- GÉANT core PoPs likely to remain in the current location long term
- Regional studies, NRENs input and further analysis to clarify rest of fibre footprint
- NRENs fibre sharing via alien waves could be used to increase network meshing and provide connectivity outside the two main rings



Iberian Peninsula and France

South East Europe

Nordics and Baltics

www.geant.org





Network Evolution – Timelines

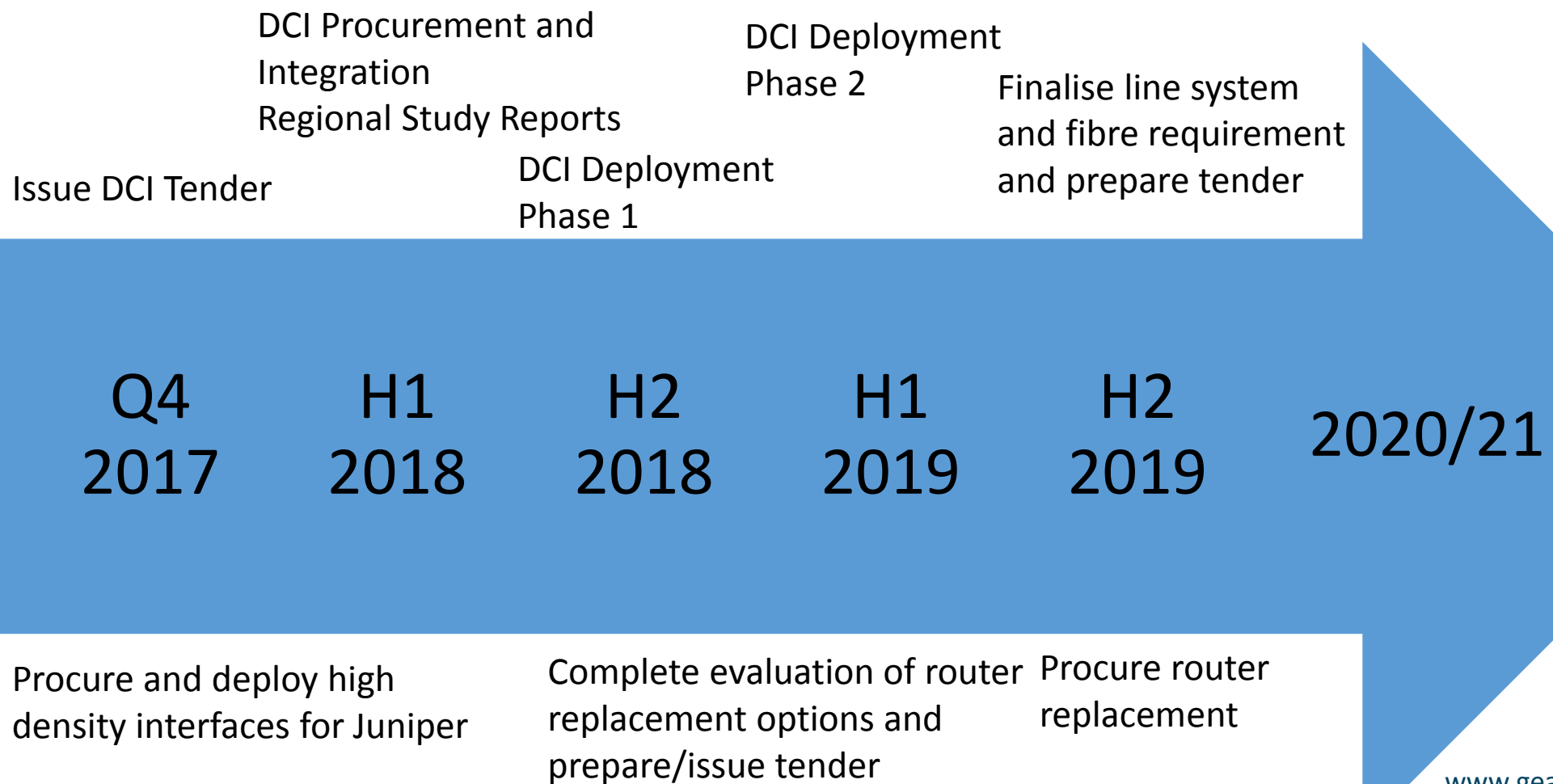



Network Evolution – Summary

- Lab testing of DCI boxes
 - Facebook Voyager - Completed (including field trial)
 - Juniper DWDM CFP2 100G ACO - Completed (including field trial)
 - Coriant Grove G30 – Completed
 - Acacia CFP2 DCO – Completed (including field trial)
- Packet Box and Network Operating Systems
 - Corsa and Metaswitch Routing Stack – Q4 2017
 - Agema and OcNOS (IPInfusion) – Q4 2017
- SA1 and JRA1 to work together to define the network management software requirements and organise a software architecture meeting with NREN



Thank you

www.geant.org



© GEANT Limited on behalf of the GN4 Phase 2 project (GN4-2).
The research leading to these results has received funding from the European Union's Horizon 2020 research and innovation programme under Grant Agreement No. 731122 (GN4-2).

GÉANT TRAFFIC PB PER QUARTER

